

# ASTRA

## CM-16 USER GUIDE



# Table of Contents

---

<b>Introduction</b> .....	<b>1</b>
Emergency Service Feature .....	1
Unpacking the Phone .....	1
<b>Key Description</b> .....	<b>2</b>
<b>Installation</b> .....	<b>4</b>
<b>Prompts and Indicators</b> .....	<b>6</b>
How do I use softkeys? .....	6
Display Prompts .....	6
<b>SAFETY INFORMATION</b> .....	<b>2</b>
Handset and Base Station .....	2
Batteries .....	2
<b>INSTALLATION</b> .....	<b>4</b>
Base Station Location .....	4
Base Station Wall Mounting .....	5
Base Unit Connections .....	5
Charging Cradle .....	7
Battery Charging .....	7
Belt Clip .....	7
Using a Headset with your Telephone .....	8
Battery Status Icons .....	8
<b>CM-16 HANDSET KEY FUNCTIONS</b> .....	<b>9, 10</b>
Screen Display .....	11
Screen Icons .....	11
Screen Prompts .....	12
Making and Answering Calls .....	13
Redial .....	13
Hold function .....	14
Mute Key .....	14
Ringer/Alerter tones .....	14
Volume Control .....	14
To adjust the receiver volume .....	15
To adjust the ringer volume .....	15
Status Light .....	15
Feature Key List .....	15
<b>OPTIONS</b> .....	<b>16</b>
Language .....	16
Key Label .....	17
To edit key label text .....	17
To delete a single key label .....	17
To delete all feature label text .....	17
Ring Tone .....	18
Custom Name .....	18
Call Timer .....	18

# Table of Contents

---

Vibrate .....	19
Handset Pairing .....	19
Key Lock .....	19
Backlight .....	20
Silent Alert .....	20
Directory .....	21
Adding a name and number to the Directory .....	21
Entering Letters and Characters .....	21
Finding entries in the Directory .....	22
Dialing from the Directory .....	22
Changing entries in the Directory .....	23
Deleting an entry in the Directory .....	23
Appendix A .....	24
Limited Warranty .....	26

## SAFETY INFORMATION

---

Prior to installing and using the telephone, please read the following important safety information.

### Handset and Base Station

Do not:

- Rely only on this telephone as your only means of communication in the event of an emergency. As this handset uses radio signals, a connection to the telephone network cannot be guaranteed in all circumstances.
- Use this handset near medical equipment such as pacemakers.
- Place the handset in areas subject to explosive hazards, flammable liquids or gases.
- Set up and use the handset close to devices that emit electromagnetic fields (i.e. electric motors, household appliances, fluorescent lamps, computers, radios, televisions, VCR's, DVD's etc.) Operation of the handset could be adversely affected if exposed to such fields and, at minimum, subject to interference and poorer quality voice communication.
- Locate the handset and base station near water, moisture, damp areas, heat sources, direct sunlight, areas with excessive dust, vibration or temperature extremes.
- Clean the handset using any chemical or commercial cleaner. Use only an anti-static or soft moistened cloth to clean the handset. Disconnect the charger stand prior to cleaning.

**NOTE:** Privacy of communications may not be ensured when using this phone. The antenna used for the base station transmitter must be installed to provide a separation distance of at least 20 cm from all persons.

### Batteries

**Please observe the following guidelines when dealing with the batteries:**

- Never tamper with or dismantle the battery pack
- Avoid touching the battery contacts
- If necessary, clean the contacts with a damp cloth
- Protect the battery contacts from contact with any metal objects
- Never immerse batteries in water or throw them into a fire

**When setting up the phone:**

- Use only the rechargeable batteries supplied with this product
- Follow the battery installation instructions included with this guide

**NOTE:** That it takes two to three charging cycles for the batteries to reach their fully charged state.

- Charge the batteries using only the charger stand supplied with this product

**In operation:**

- It is normal for the batteries to become warm when charging.
- Discharge the batteries from time to time to prolong their service life. To do this, do not place the phone back into the charger stand until the batteries are completely or almost completely discharged. The battery icon on the display will indicate when the batteries are low and an alert tone is sounded every three minutes.
- Only use batteries and charging units approved by the manufacturer.
- If you do not intend to use the phone for an extended period, the batteries should be removed from the handset.
- Store batteries at room temperature. Above average temperatures tend to reduce the service life of batteries.
- Do not throw away or incinerate used batteries. Take them to an appropriate collection point for recycling or send them back to your supplier or distributor.

**The batteries included with the CM-16 are designed to provide up to four hours talk time and eighty hours standby time. Actual battery performance can be affected by a wide variety of environmental and user factors.**

## REGULATORY INFORMATION

---

Any changes or modifications not expressly approved by the party responsible for compliance could void the user's authority to operate the equipment

This class B device complies with Part 15 of the FCC rules and ICES-003 Class B Canadian EMI requirements. Operation is subject to the following two conditions: (1) This device may not cause harmful interference and (2) This device must accept interference received, including interference that may cause undesired operation.

For body worn operation, this phone has been tested and meets the FCC RF exposure guidelines when used with Aastra Telecom accessories supplied or designated for this product. Use of other accessories may not ensure compliance with FCC RF exposure guidelines.

Highest reported SAR values are as follows: Head: 0.05 W/kg; Body: 0.33 W/kg.

FCC ID: SDVCM16

IC: 1884A-CM16

## INSTALLATION

The CM-16 consists of a base station, wireless handset and a charging base stand. The following diagram provides an overview of the installation of the product using the power supply provided. Detailed installation instructions are provided below.

**NOTE:** Your System Administrator must be aware that the CM-16 emulates the M2616 in order to correctly configure the switch/communications server software to allow this phone to operate.

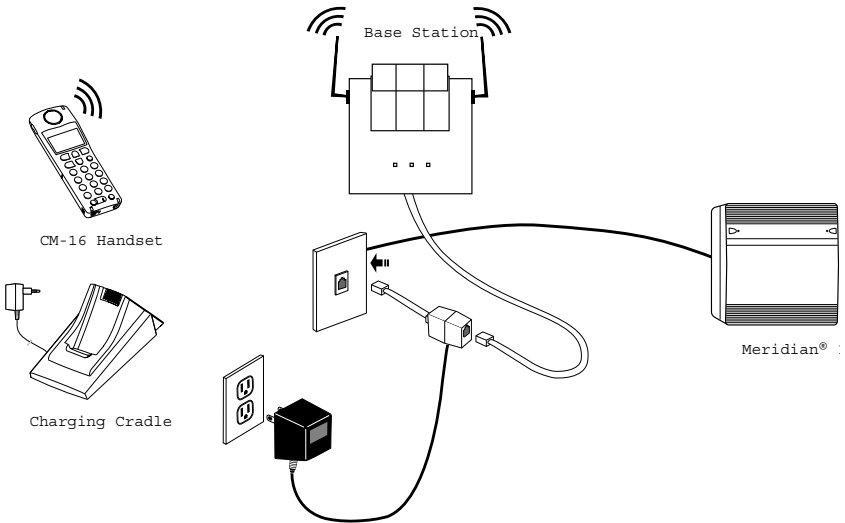

### Base Station Location

The CM-16 base station has three LED indicators that provide operational and installation diagnostic feedback. Please see **“APPENDIX A” on page 25** for a detailed chart of LED signals and their meaning.

The base station can be placed on a flat surface or be wall mounted. For optimum range performance, wall mounting is recommended.

Location of the base station can have significant impact on performance. It is recommended that the base station be located:

- Away from metal objects such as filing cabinets, metal blinds or other metal support structures
- Away from other electronic devices such as CRT's, desktop computers and other cordless products
- As high as possible with the antennas pointing up in a vertical position.
- The antenna used for the base station transmitter must be installed to provide a separation distance of at least 20 cm from all persons.

## Base Station Wall Mounting

To wall mount the base station:

- Locate the wall mounting strip located on the back side of the base station
- Slide the strip out from the base station (Fig A)
- Turn the strip around and secure firmly to the wall using the screws supplied (Fig B)
- Plug the line cord into the jack on the unit
- Slide the base station over the strip until it clicks into place (Fig C)

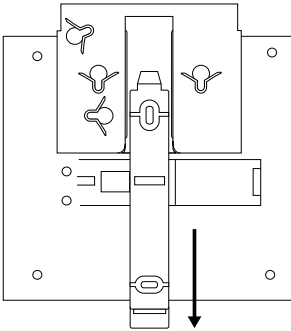

Figure A

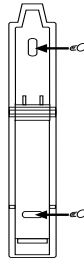

Figure B

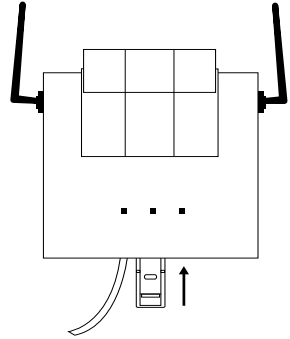

Figure C

The installation process is divided into three sections A, B, and C.

If you follow the steps in order, the Handset and Base Unit will properly synchronize with the M1 2616 port. At this time per Figure 2, prepare the handset by placing the battery cover and the battery near the handset so you can connect it quickly in step B5.

### Configure the 2616 Port and wall jack

If you have not already configured and verified a 2616 port, do so now.

The Base Unit will not operate unless connected to a working M1 circuit and the handset won't work or even charge the battery properly unless the Base Unit is operational first.

### Base Unit Connections

The Base Unit must be connected to a known working M1 port configured for a 2616 wired set. Where possible, verify the port and key assignments by using a 2616 set before connecting the CM-16 to that jack.

**Refer to Figure 1 and connect the components in this order.**

1. Plug one end of the 6 conductor cord (supplied) to the Antenna Unit
2. Plug the other end of the 6 conductor cord into the jack on the Power Adapter Assembly

In the next two steps certain LEDs on the Base Unit should light up, so watch for the appropriate LED response.

- Plug the short 2 conductor line cord tail of the Power Adapter Assembly into the 2616 Jack. When a working port is detected and the polarity is correct (pin 3+ and pin 4-), the center LED will blink and the left LED will turn on steady. If both LEDs are not indicating as described, stop the installation and verify the M1 port is working at the intended jack with a 2616 set. Next, verify all modular cord connections to this point are correct and making good contact. When both LEDs are indicating properly, continue at step 4.

Figure 1 CM-16 Base Unit Connections

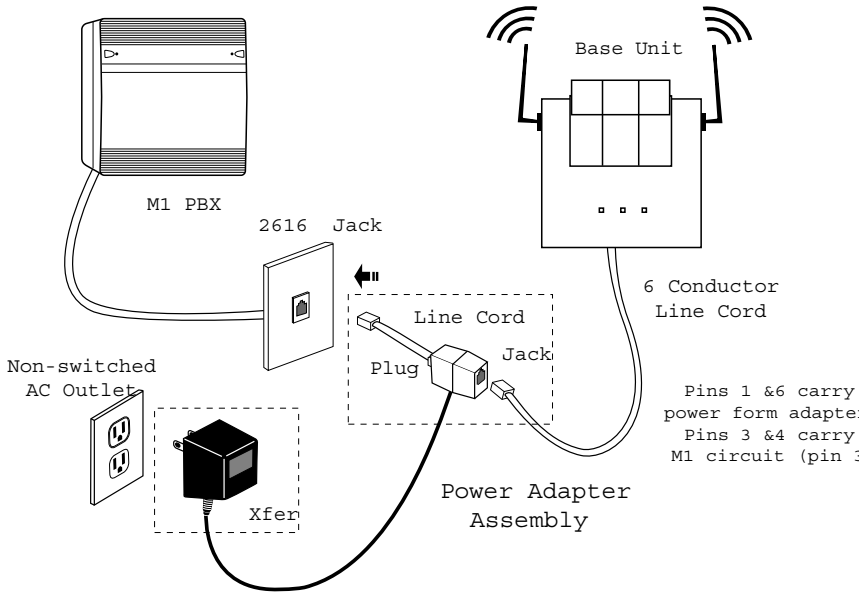

- Plug the power adapter transformer (Xfmr) into a non-switched 120V AC outlet. The right LED will blink for about 40 seconds as the Base Unit scans for its Handset. This indicates the radio circuit has been properly powered. Go to step 5 to link the handset. If the right LED doesn't blink, verify the AC outlet is working and that the power adapter prongs fit snugly in the outlet. Try another outlet just to be sure. Once the right LED is blinking, continue at step 5.
- While the Base Unit is scanning (right LED blinking), connect the battery to the handset. Place the battery in the compartment and slide the door closed. The handset should initialize and remain powered for a couple of minutes, enough time to link with the Antenna Unit and allow you to place a test call. Watch the handset display. As the handset initializes, two icons will appear in the top left corner. The left icon is the battery symbol and the internal bars of the icon show the remaining charge. The other important icon that must appear is the Antenna just to the right of the battery icon. When the Antenna icon appears, place a test call.

**Place a test call...**

From another M1 station, call this DN and answer the call by pressing the Handset Button (to the left of the **M** button). Verify two way transmission and hang up by pressing the button to the right of the **M** button.

**Figure 2 Handset Preparation**

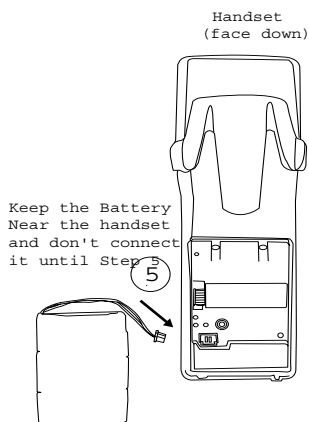

**Figure 3 Charger Preparation**

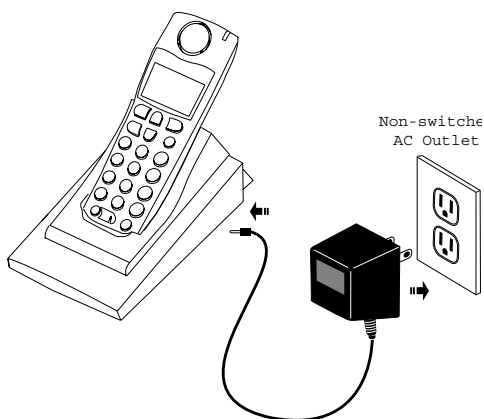

**Charging Cradle**

Refer to Figure 3.

1. Plug the modular cord of the “cradle power adapter” into the jack on the bottom of the cradle. Route the cord through the retaining tabs of the molded cord slot. Verify the cradle rests on all four feet and doesn't wobble.
2. Plug the transformer into a known working non-switched AC outlet and place the handset, face up in the charging cradle. There is no power light on the cradle. However, once the handset is placed in the cradle, the battery icon will blink indicating the battery is being charged. Should the icon not blink, check the battery compartment cover to ensure it is properly closed. If the handset does not easily slide into the charging cradle, the battery compartment cover is likely not installed correctly.

**The Handset (battery) needs to be charged at least 6 hours before use.**

**Belt Clip**



To install the belt clip, snap one arm of the clip into the slot on the side of the handset and then slide the other arm into the slot on the other side of the handset until it snaps into place.

## Using a Headset with your Telephone

The CM-16 accepts headsets through the jack on the bottom of the handset. Contact your telephone equipment retailer or distributor to purchase a compatible headset. Customers should read and observe all safety recommendations contained in headset operating guides when using any headset.

## Battery Status Icons



The display provides “at a glance” information on the handset battery

	The bars indicate the battery charge level – 4 for full, needs recharging when only 1 bar appears.
	The bars will flash when the battery is being recharged on the charger stand.

**NOTE:** The handset is designed to recharge the batteries automatically, when required and placed on the charger stand. The battery icon will not flash and the handset does not charge every time it is placed on the stand. If a defective battery is replaced, then the battery icon is not identified until the new battery is charged for at least 2 minutes.

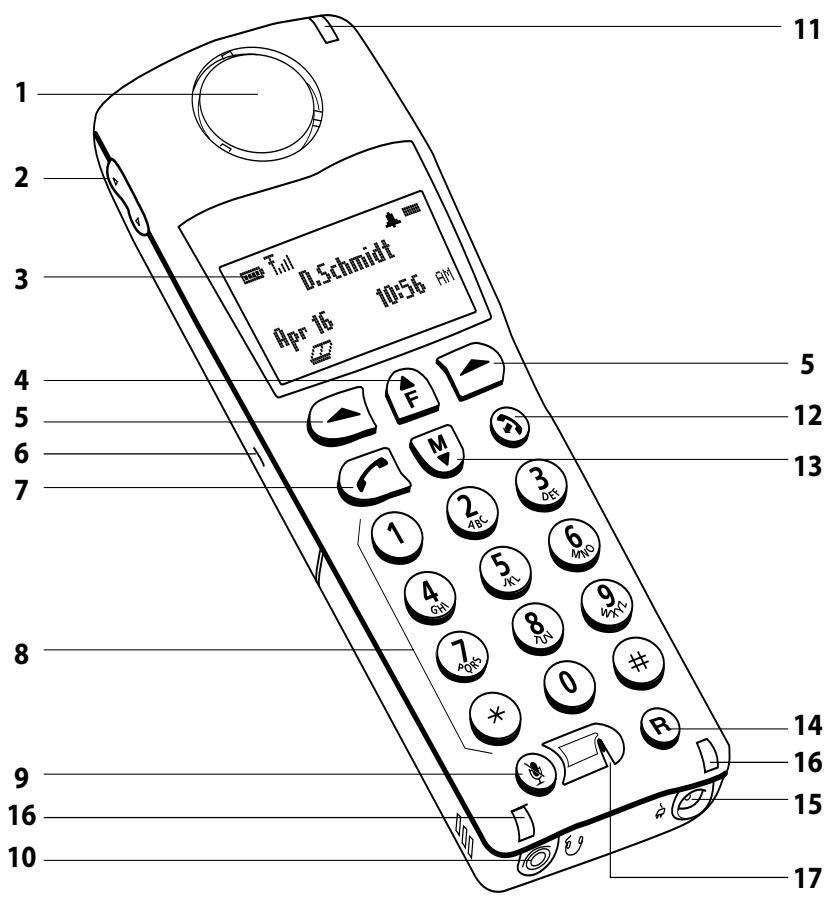
CM-16 HANDSET KEY FUNCTIONS



Function #	Function Description
1	<b>Receiver</b>
2	<b>Volume key</b> <ul style="list-style-type: none"> <li>• During Ringing: Adjusts ringer volume</li> <li>• During a call: Adjusts receiver volume</li> <li>• During text mode (not in a call): Moves cursor right/left</li> </ul>
3	<b>Display</b>
4	<b>Features F Key List</b> <ul style="list-style-type: none"> <li>• Access key to the M1 Feature key list</li> <li>• Scrolls up when in the various lists</li> <li>• Add a space during editing</li> </ul>
5	<b>Softkeys</b> <ul style="list-style-type: none"> <li>• Activates feature or option shown on the display above the keys</li> </ul>
6	<b>Call key</b>  <ul style="list-style-type: none"> <li>• Used to obtain dial tone</li> <li>• Also used as a Hold key</li> </ul>
7	<b>Mute</b>  <b>key</b> <ul style="list-style-type: none"> <li>• When used, prevents the caller from hearing you</li> </ul>
8	<b>Headset jack</b>
9	<b>Status Light</b>
10	<b>Release</b>  <b>key</b> <ul style="list-style-type: none"> <li>• To end calls and go on hook</li> <li>• Exits Menu and the various lists.</li> </ul>
11	<b>Menu M key</b> <ul style="list-style-type: none"> <li>• Access key to the different Options</li> <li>• Scrolls down when in the various lists.</li> <li>• Used as Backspace during editing</li> </ul>
12	<b>Redial R key</b> <ul style="list-style-type: none"> <li>• Displays the last 10 numbers dialed</li> </ul>
13	<b>Charging jack</b>
14	<b>Charging contacts</b>
15	<b>Microphone</b>

## SCREEN

---

### Screen Display







The screen display on the CM-16 provides five lines, 15 characters per line of display area. Pressing any key will light up the display if the Backlight option is On.



The display provides a variety of information, using text or icons, pertaining to set status, including battery strength, reception range and selected settings. Caller information, option menus, instructions, time and date and general information about calls in progress may also appear.

In addition, at the bottom of the screen display, softkey functions will appear. These functions or options change based on activity and can be activated by pressing the appropriate key just below the display. For M1 functions, the screen can display functions that are activated by pressing the softkey. See the “**FEATURES LIST**” on **page 16** of this guide for more information.

**NOTE:** Whenever the display indicates Use ▼▲ to view use the ▲ key to scroll up and the M key to scroll down.

### Screen Icons

	<p><b>Battery Strength</b> 4 bars for battery full and the bars flash when charging</p>
	<p><b>Reception Range</b> Indicates that the handset is within range of the Base Station and that the Base Station is powered.</p>
	<p><b>Call in progress</b> Indicates that you are off hook</p>
	<p><b>Message Waiting</b> Indicates a message waiting</p>
	<p><b>Vibrate</b> Vibrate activated * This symbol indicates that vibrate is active. The difference between vibrate and silent alert is that the phone will also ring in vibrate mode, but will not in silent alert mode.</p>
	<p><b>Directory</b> Directory, which can store up to 50 names and numbers in alphabetical order. Note that the Directory Softkey can be overwritten by a feature key during a call. The directory softkey can always be accessed from within the options list.</p>

	<p><b>Ringer Volume</b></p> <p>This Icon appears when the phone is not in use to indicate the ringer volume level. As the ringer volume level is increased, from off to high, the box will go from empty to fully black.</p> <p>This icon does not appear when silent alert is activated.</p> <p>The bell icon and the vibrate icon can be present at the same time. This means both the vibrate and audio alerters are active. If the vibrate icon is shown, that means the phone is in silent alert mode. If just the bell is displayed, then the phone is in normal alert mode with only the audible alert active.</p>
	<p><b>Receiver Volume</b></p> <p>This Icon is available only when the phone is Off hook.</p> <p>Displays the receiver audio volume from low to high with the box gradually filling up as the volume level is increased.</p>

### Screen Prompts

Display Message	Description
Microphone mute	Indicates when the Mute button has been Activated
Out of range	Appears briefly when pressing a key if out of range of the base station
Check Line Cord	Will appear if the line cord is not properly connected to the base station.



## MAKING AND ANSWERING CALLS

---

### **To make a call:**

Press the  key to obtain dial tone and use the Keypad to dial the number

**OR**

Redial the number first using the Keypad. The number, as entered, will appear on the display. If the number is correct, press the  key to dial the number. If number is incorrect use the  key or press down on the volume key to erase digits from right to left.

If you need to add a pause to a number (for example, between a telephone number and an access code) press the **PauseKey** softkey to insert a 2 second pause into the number.

Calls can also be made directly from the Directory. See the “**DIRECTORY**” on **page 22** for further information.

### **To end a call:**

Press  key

**OR**

Return the handset to the charging cradle.



### **To answer a call:**

Press the  key to answer an incoming call or lift the handset out of the charging cradle.

## **Redial**

To redial the last 10 numbers:



### **When on hook**

- Press **R** key, and use the  and the  keys to scroll up and down through the list of the last ten numbers dialed
- Press the  key to dial the selected number or press the **Line** softkey to select an outgoing line and the **Select** softkey and the selected number will automatically be redialed

### **When off hook**

- Press **R** key and the last number dialed will automatically be redialed. In addition to redialing the last 10 numbers, the CM-16 allows redialed numbers to be deleted from the redial list or saved to the Directory, while on hook.

### **To add a redialed number to the directory:**

- Press **R** key, and use the  and the  keys to scroll up and down through the list of the last ten numbers dialed.
- Once the selected number appears on the display, press the **Options** softkey – the display shows **Save 4Directory** and **s=Next**
- Press the **Select** softkey. If there is no name associated with the

number, the display will prompt, to enter a name to save the entry. Use the instructions in the section **Adding a Name and Number to the Directory** to save the entry in the Directory. If there is a name associated with the number it will automatically save it to the directory and briefly indicate *item saved*.

#### **To delete an entry in the Redial list:**

- Press **R** key, and use the **▲** and the **▼** keys to scroll up and down through the list of the last ten numbers dialed
- Once the selected number appears on the display, press the **Options** softkey and the **▼** key once — the display shows **Delete and s=Next**
- Press the **Select** softkey. The display will show **Delete again to erase this item**.
- Press the **Delete** softkey to erase the entry. Display shows **Item erased**. You can return to the main display any time by pressing the **↶** key.

### **Hold Function**

To place a call on hold, press the **☞** key. To take a call off hold, press the **☞** key again.

### **Mute Key**

Use the mute key when you want to be able to hear a caller but have them not hear you. Press the **🔇** key to mute the handset. Press the **🔇** key again to disengage mute.

### **Alerter Tones**

The CM-16 uses tones to provide information as follows:

<b>Low Battery</b>	one tone every three minutes
<b>Out of Range</b>	whenever handset loses connection to base station
<b>Check Line Cord</b>	Whenever you try to establish a link with the base station and the DC power is not plugged in and/or the line cord is not plugged into the base.

### **Volume Control**

The volume key, located on the side of the handset, controls both the receiver and ringer volume.

**NOTE:** The volume key can also be used to adjust the right/left cursor to add spaces or to erase characters on the display when editing or creating names, key labels etc.

#### **To adjust the receiver volume:**

- While on a call, press the top of the key to increase the receiver volume and press the bottom of the key to decrease the volume. The receiver volume icon on display will indicate the current volume level. In absence of a PBX, the receiver volume returns to the default setting after each call. However,

the PBX directive can direct the handset default to the volume.

**To adjust the ringer volume:**

- When the handset is not being used for a call, press the top of the key to increase the ringer volume and press the bottom of the key to decrease the ringer volume. The handset ringer will sound on each adjustment to reflect the new setting and the ringer volume icon on display will also show the current level chosen.

**Status Light**

The green LED light on the handset indicates the following conditions:

<b>Incoming call</b>	flashes rapidly	<b>Call on hold</b>	solid green
Handset muted	flashes rapidly	<b>Features activated</b> (only while on hook) / <b>message waiting</b>	solid green

## FEATURES LIST

---

There are 14 Meridian features available through the CM-16. The features list can be accessed through the Feature **F** key of the CM-16. When scrolling through the features list, a darker scroll bar highlights the feature that can be selected. If the Meridian features are labeled instead of pre-programmed and identified on handset, the features list on the CM-16 menu display will be identified by item numbers from 00 to 14 with no text (example <09>) **Note that Meridian Key 07 and 15 features are not available on the CM-16.** Also, the first key <00> in the list will always be the primary DN.

- Each feature can be labeled manually through the Edit option. See the “**Key Label**” option in this guide for detailed labeling instructions.
- The ► indicates that the feature is activated or flashing during the program state.
- To activate one of the features press the **Select** Softkey.

To cancel an activated M1 feature key, press the **Cancel** Softkey or  key to end the call.

See your system administrator, *M2616 Quick Reference guide* or visit the Nortel Networks website for further information on Meridian features available.

## OPTIONS

---

### To access the options list:

1. Press the **M** key when the phone is not in use — the display will indicate **Use ▲▼ to view**. Use the **▲** and **▼** keys for scrolling.
2. There are ten options that can be accessed by either scrolling to the option or by using the keypad to dial the option number as per the table below.

Option	# Options list
<b>1</b>	Language
<b>2</b>	Key label
<b>3</b>	Ring tone
<b>4</b>	Custom name
<b>5</b>	Timer Off
<b>6</b>	Vibrate Off
<b>7</b>	Hset pairing
<b>8</b>	Key lock Off
<b>9</b>	Backlight Off
<b>10</b>	Silent Alert Off

**NOTE:** The Menu and Options display revert to the regular idle mode display if no action/activity is initiated within 20 seconds.

Press **↶** key to quit at any time and to return to the main idle display screen.

### Language

The CM-16 offers a choice of English, French and Spanish display languages.

The default language setting is English. The language display in use is always identified with a check mark.

To change the display language, follow the display menu prompts using the two softkeys as required to change, cancel or select a language option.

The display will always show **-confirmed-** when the selection is changed.

Pressing the **Cancel** softkey will return you to the previous display.

Pressing the **↶** key will return you to the main idle display screen.

## Key label

The Key label option gives access to the display text associated with the 14 Meridian features that can be programmed with to CM-16 handset.

Text to identify a specific feature can be added, modified or deleted or all feature key text can be deleted at once. Labels can have up to 14 characters.

### *To edit key label text*

Press the **Change** softkey from the key label display

- At the Edit display screen, press **Select** softkey — this will display the key label **00**
- Use the scroll keys to find the feature key desired
- Press the **Edit** softkey
- Use the keypad to type out a new label or use the scroll keys **▲** and **▼** to move the cursor to the desired display position or to erase text. (See “**Entering Letters and Characters**” on page 22 in the Directory portion of this guide for additional details regarding adding a name using the keypad)
- The **ChCase** softkey changes the screen text between Upper and Lower case
- The **Save** softkey saves changes made

Use the **↶** key at any time to exit the option menu.

**NOTE:** In editing mode, the Volume Bar can be used in place of the (**▲** and **▼**) keys to control the screen cursor

- Press the Lower end volume bar for Backspace/Erase
- Press the Higher end volume bar to add a Space

### *To delete a single key label*

- At the Edit display screen: Press the **Change** softkey from the key label display
- Press **Select** softkey — this will display the key label **00**
- Use the scroll keys to find the feature key desired
- Press **Delete** to delete the text associated with the feature

### *To delete all feature label text*

- Press the **Change** softkey from the key label display
- Press the **▼** key to move to the **Delete All** option display
- Press **Select** softkey — display indicates **Press delete to confirm**
- Press **Delete** softkey to delete all labels

## Ring Tone

The CM-16 offers the choice of four different ring tones.

To change the ring tone, follow the display menu prompts using the two softkeys as required to change, cancel or select a ring tone. Each of the four ring tones can be heard prior to selection. The display will always show **-confirmed-** to indicate when a selection has been made.

Pressing the **Cancel** softkey returns you to the options list.

Pressing the **↶** key returns you to the main idle display screen.

## Custom Name

This option allows a name or extension number etc. to be added/edited and displayed in idle mode. In a multi-handset environment, this is an ideal option to personalize each handset to its user or extension number.

From the Custom name option display, press the **Change** softkey and then the **Edit** softkey. If an existing custom name already appears on the display, the **Delete** softkey is also shown and can be used to delete a custom name.

- Use the keypad to type out a new label or use the scroll keys **▲** and **▼** to move the cursor to the desired display position or to erase text. (See “**Changing entries in the Directory**” on page 23 in the “Directory” for additional details.)
- The **ChCase** softkey changes the screen text between upper and lower case
- The **Save** softkey saves changes made

Pressing the **↶** key returns you to the main idle display screen.

**NOTE:** In editing mode, the Volume Bar can be used in place of the (**▲** and **▼**) keys to control the screen cursor

- Press the Lower end volume bar for Backspace/Erase
- Press the Higher end volume bar to add a Space

## Call Timer

The duration of calls can be displayed by using this option. By default, the Call Timer option is always Off.

To turn the timer on, press the **Change** softkey and the display will indicate **Timer On** and **-confirmed-** and will quickly return to the previous menu display.

Pressing the **↶** key will return you to the main idle display screen.

## Vibrate

The Vibrate option allows the CM-16 handset to signal an incoming call by vibrating as well as ringing. By default, this option is always Off.

To enable this feature, press the **Change** softkey and the display will indicate **Vibrate On** and **-confirmed-** and will quickly return to the previous menu display.

Once the Vibrate is On, the  is shown beside the ringer icon on the top right line of the display.

Pressing the  key will return you to the main idle display screen.

## Handset Pairing

The Handset Pairing option provides flexibility by allowing any CM-16 handset to work with any CM-16 base station. Each handset is factory programmed to work only with the base station shipped with the product.

When using this option, be sure to keep the handset at least a few feet away from the base station. The handset does not need to be placed right in front of the base station when pairing and may not, in fact, be able to pair if too close to the base station.

To program the handset to work with another CM-16 base station in this option, press the **Change** softkey and the display will indicate **Attempting Pairing**. If successful, the display will indicate **Pairing successful**. If the pairing does not occur, the display will indicate **Pairing failed Try again**.

Pressing the  key will return you to the main idle display screen.

## Key Lock

The key lock option enables the user to lock the keypad keys. This prevents accidental activation of the phone while carrying it, putting in a pocket etc.

To lock the keys from the key lock option page:

- Press **Change** softkey to turn Key lock ON or Off. The screen will display **Key lock On** or **Key lock Off -confirmed-**

Pressing the  key will return you to the main idle display screen.

**NOTE:** You can active the Key Lock Off or On by pressing only the **M** key and then the **\*** asterisk key.

## Backlight

The Backlight option enables the user to have the display diffuser lighted or not when a keypad key is pressed. Press **Change** softkey to turn Backlight ON or Off.

Once the Backlight option is chosen, the screen will display **Backlight On** or **Backlight Off -confirmed-**



## Silent Alert

The Silent Alert option will activate an internal hardware vibrator instead of a regular ringer during an incoming call. By default, the Silent Alert is automatically set to Off.

To activate Silent Alert from the option display:

- Press **Change** softkey to turn alert On or Off. The display will show ~~-confirmed-~~ and the handset will vibrate if the alert has been turned on

Once the Alert is On, the  is shown on the Top line of the display.

**NOTE:** You can active or deactivate the Silent alert by pressing only the  key and then the  key.

**NOTE:** The Ringer Icon does not appear on the display when the Silent alert is On.

## DIRECTORY

---

The directory can store up to 50 names and numbers, which are displayed in alphabetical order. If no name is entered, the entries are sorted by number, at the beginning of the directory.

### Adding a name and number to the Directory

---

1. Press **Directory**  softkey

---

2. Press **Add** softkey. Display prompts **Enter number**

---

3. Enter the number using the keypad. You can enter up to 24 digits. Hyphens will be automatically added. If you need to enter a pause (between your voice mail number and password, for example) press the **PauseKey** softkey and the pause icon will appear. To erase a digit, use the **M** key or press the bottom of the volume bar.

---

4. Press the **Save** softkey. The display will prompt **Enter name**. If no name is to be used for this directory entry, press the **Save** softkey again, the display will show **Item saved**

---

5. Enter a name using the letters on the dial pad. The name can have up to 15 characters, including spaces. See the section **Entering Letters and Characters** for more details regarding entering text on display.  
To erase a letter or to add a space use the **^** and **M** keys or the volume bar to move the screen cursor position.

---

6. Press the **Save** softkey. The display will show **Item saved**.

---

Pressing the  key will return you to the main idle display screen. If this key is pressed before the item is saved, it will not be saved.

**NOTE:** Names and numbers can also be copied into the Directory from the Redial list. See the “**Redial**” on page 13 for additional details.

### Entering Letters and Characters

You can enter characters using the telephone’s dial pad. To enter a letter, press the key with that letter on it. If the letter is the second one on that key, press the key twice. For example, to enter the letter “r”, press the 7 key three times. The cursor will then advance to the next space.



To change the case of a letter, press the **ChCase** softkey and then enter the letter. By default, the first letter of a word or name will be capitalized and the letters following will be lower case.

Special characters are entered by pressing the 1 key. Characters will appear in this order: , - ‘ \* . ()

## Finding entries in the Directory

1. Press Directory  softkey

---

2. Use the  and  keys to scroll up and down one listing at a time OR use the dial pad keys to identify entries starting with a certain letter. For example, to find directory entries starting with the letter "S". press the 7 key four times. The first entry will appear. If there are more directory listings using the letter "S", you must type in the second letter of the name.

## Dialing from the Directory

1. Press Directory  softkey

---

2. Find the entry you wish to call in the Directory

---

3. Press the  key to dial the number or use the Line softkey, where available, to use a different line to place the call

## Changing entries in the Directory

1. Press Directory  softkey



---

2. Find the entry you wish to change in the Directory

---

3. Press **Options** softkey

---

4. Press  key once. Display shows **Edit** and =Next

---

5. Press **Select** softkey. The current stored telephone number for the directory entry appears on the display. Use the  key or press the bottom of the volume bar to erase a number and use the keypad to correct the telephone number.

---

6. Press the **Save** softkey to save the change to the phone number. The display then prompts you to **Enter name**. If required, change the name using the instructions found in the "**Adding a name and number to the Directory**" on page 22 section of this guide.

---

7. Press the **Save** softkey to save the revised Directory entry. Will display **Item saved**.

Pressing the  key will return you to the main idle display screen.

## Deleting an entry in the Directory

1. Press Directory  softkey
2. Find the entry you wish to delete in the Directory
3. Press Options softkey
4. Press **M** key twice. Displays **Delete** and **Next**
5. Press **Select** softkey. Displays **Press Delete to confirm**
6. Press the **Delete** softkey. Displays **Item erased**

Pressing the  key will return you to the main idle display screen.

## Deleting all entries in the Directory

1. Press Directory  softkey
2. Press **Delete** softkey. Display shows **Press Delete to erase all**
3. Press the **Delete** softkey. Display shows **All items erased**

## APPENDIX A

The CM-16 base station has three LED indicators. Refer to the following diagram to correctly relate the LED designation to the information supplied in this Appendix.

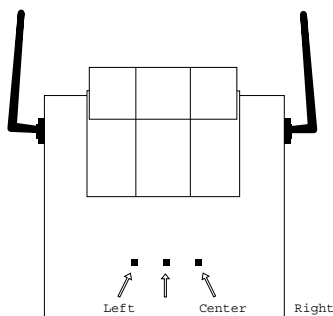

Each of these LED's provides system status information as follows:

### Left LED

Led State	Meaning
Solid Off	Base is NOT supplied switch line power.
Solid On	Base is supplied switch line power

The left LED on the CM-16 Base is currently tied to Vcc (Meridian switch power).

### Center LED

The center LED is controlled by the base MCU and indicates Meridian switch communications status.

Led State	Meaning
Flashing ~2Hz	Base properly communicating with the switch.
Solid Off	Base has no line power. (Same as solid off for left LED)
Flash once every 2 seconds / Solid On	Base is receiving power from the switch but is cannot communicate properly.

**Right LED**

The right LED indicates radio status, both radio link activity and registration activity.

<b>Led State</b>	<b>Meaning</b>
Solid Off	There is no radio link and the base is not attempting to pair.
Solid On	The base is currently in a radio link state with a handset
Flashing Rapidly	Base is attempting a pairing with a handset (enters this mode at power up in addition to pairing button press)

## LIMITED WARRANTY

---

Aastra Telecom warrants this product against defects and malfunctions during a one (1) year period from the date of original purchase. If there is a defect or malfunction, Aastra Telecom shall, at its option, and as the exclusive remedy, either repair or replace the telephone set at no charge, if returned within the warranty period.

If replacement parts are used in making repairs, these parts may be refurbished, or may contain refurbished materials. If it is necessary to replace the telephone set, it may be replaced with a refurbished telephone of the same design and color.

If it should become necessary to repair or replace a defective or malfunctioning telephone set under this warranty, the provisions of this warranty shall apply to the repaired or replaced telephone set until the expiration of ninety (90) days from the date of pick up, or the date of shipment to you, of the repaired or replacement set, or until the end of the original warranty period, whichever is later. Proof of the original purchase date is to be provided with all telephone sets returned for warranty repairs.

### ***Exclusions***

Aastra Telecom does not warrant its telephone sets to be compatible with the equipment of any particular telephone company. This warranty does not extend to damage to products resulting from improper installation or operation, alteration, accident, neglect, abuse, misuse, fire or natural causes such as storms or floods, after the telephone is in your possession.

Aastra Telecom shall not be liable for any incidental or consequential damages, including, but not limited to, loss, damage or expense directly or indirectly arising from the customers use of or inability to use this telephone, either separately or in combination with other equipment. This paragraph, however, shall not apply to consequential damages for injury to the person in the case of telephones used or bought for use primarily for personal, family or household purposes.

This warranty sets forth the entire liability and obligations of Aastra Telecom with respect to breach of warranty, and the warranties set forth or limited herein are the sole warranties and are in lieu of all other warranties, expressed or implied, including warranties or fitness for particular purpose and merchantability.

**Warranty Repair Services**

Should the set fail during the warranty period;

In North America, please call 1-800-574-1611 for further information.

Outside North America, contact your sales representative for return instructions.

You will be responsible for shipping charges, if any. When you return this telephone for warranty service, you must present proof of purchase.

**After Warranty Service**

Aastra Telecom offers ongoing repair and support for this product.

This service provides repair or replacement of your Aastra Telecom product, at Aastra Telecom's option, for a fixed charge. You are responsible for all shipping charges. For further information and shipping instructions;

In North America, contact our service information number: 1-800-574-1611.

Outside North America, contact your sales representative.

**NOTE:** Repairs to this product may be made only by the manufacturer and its authorized agents, or by others who are legally authorized. This restriction applies during and after the warranty period. Unauthorized repair will void the warranty.

# INDEX

---

## A

**Appendix A 25**

## B

**Base Station 1**

Location 4

Wall Mounting 5

**Base Unit 5**

**Batteries 1**

**Battery 8, 11, 14**

**Belt Clip 7**

## C

**Call**

redial 13

to answer 13

to end 13

to make 13

**Call in progress 11**

**Charging Cradle 7**

**Check Line Cord 14**

## D

**Directory 22**

Adding a Name and Number  
22

Changing entries 23

Deleting all Entries 24

Deleting an Entry 23

Dialing from 23

Entering Letters and Char-  
acters 22

Finding entries 23

## F

**Features List 16**

## H

**Handset 1**

**Handset and Base Station 1**

**Headset 8**

**Hold 14**

## I

**Installation 4**

## K

**Key Functions 10**

## L

**LED**

Center LED 25

Left LED 25

Right LED 26

## M

**Message Waiting 11**

**Mute 14**

## O

**Options**

Backlight 20

Call Timer 19

Custom Name 19

Handset Pairing 20

Key label 18

Key Lock 20

Language 17

Ring Tone 19

Silent Alert 21

Vibrate 19

**Out of Range 14**

## R

**Receiver Volume 12, 14**

**Reception Range 11**

**Regulatory Information 3**

**Ringer Volume 12, 15**

# INDEX

---

## S

**Safety Information 1**

**Screen**

Display 11

Icons 11

**Screen Prompts 12**

## T

**Tones 14**

## V

**Vibrate 11**

**Volume**

Receiver 14

Ringer 15

**Volume Control 14**

## W

**Wall jack 5**

If you've read this owner's manual and still have problems, please visit our website at [www.aastra.com](http://www.aastra.com) or call 1-800-574-1611 for technical assistance.

© Aastra Telecom Inc. 2005 41-0071-00 Rev 03